

Structural Brackets

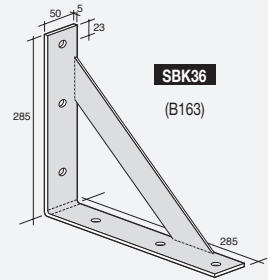
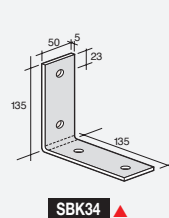
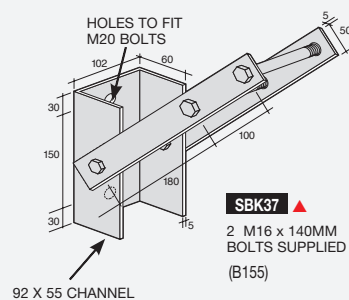
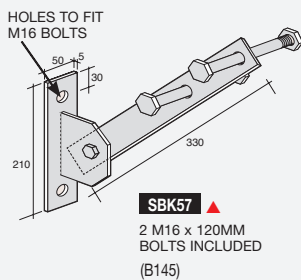
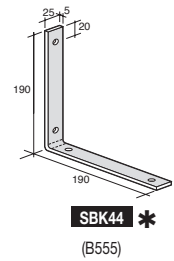
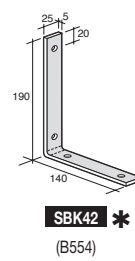
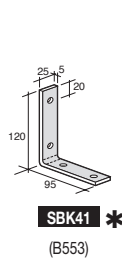
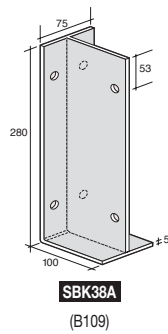
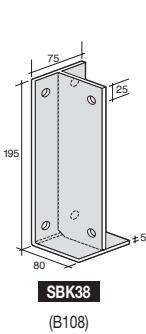
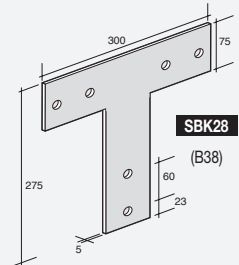
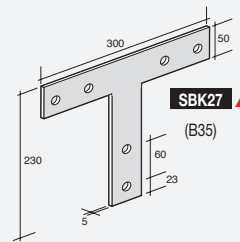
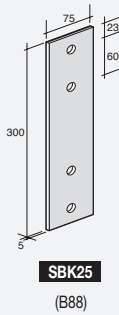
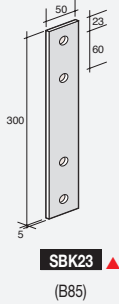
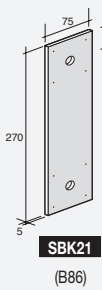
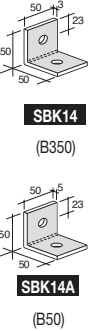
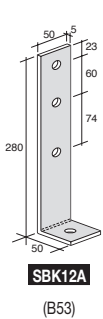
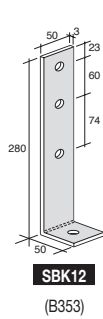
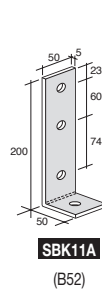
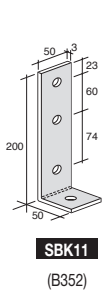
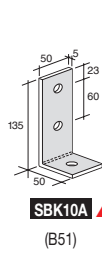
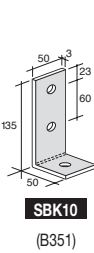
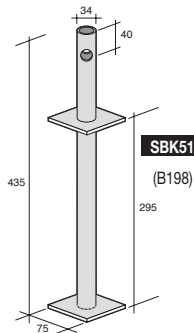
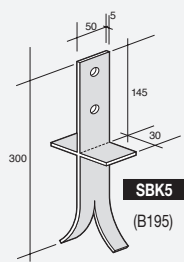
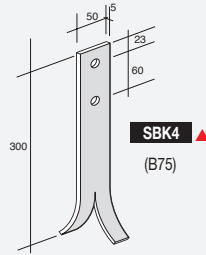
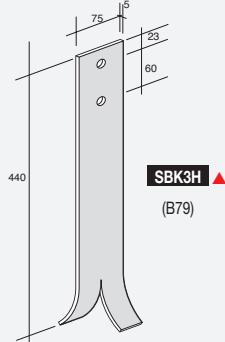
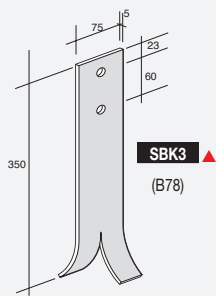

ALL BOLT HOLES TO ACCOMMODATE M12 BOLTS UNLESS NOTED.
* BRACKETS WITH HOLES FOR 6MM COUNTERSUNK SCREWS. ELECTROGALVANISED FINISH
▲ ALSO AVAILABLE IN STAINLESS STEEL

GALVANISED AND STAINLESS STEEL PLATES AND BRACKETS FOR CONCRETE, TIMBER AND STEEL CONNECTIONS

Structural Brackets

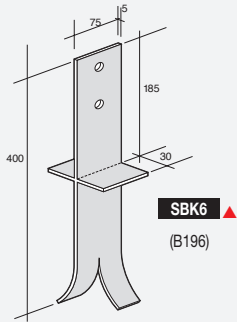

SBK6 ▲
(B196)

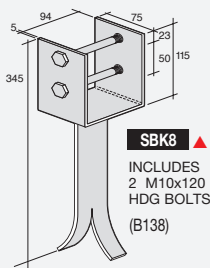

SBK8 ▲
INCLUDES
2 M10x120
HDG BOLTS
(B138)

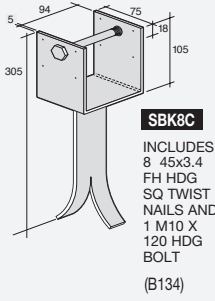

SBK8C
INCLUDES
8 45x3.4
FH HDG
SQ TWIST
NAILS AND
1 M10 X
120 HDG
BOLT
(B134)

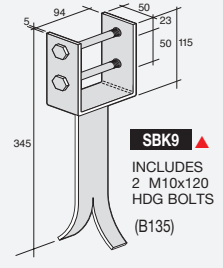

SBK9 ▲
INCLUDES
2 M10x120
HDG BOLTS
(B135)

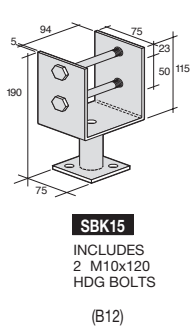

SBK15
INCLUDES
2 M10x120
HDG BOLTS
(B12)

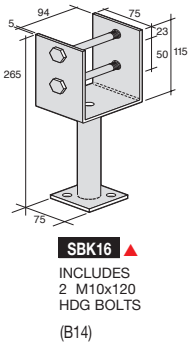

SBK16 ▲
INCLUDES
2 M10x120
HDG BOLTS
(B14)

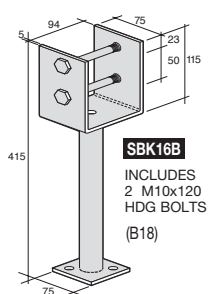

SBK16B
INCLUDES
2 M10x120
HDG BOLTS
(B18)

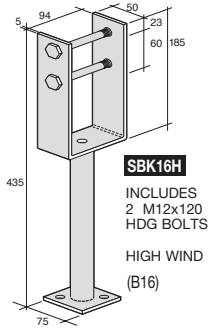

SBK16H
INCLUDES
2 M12x120
HDG BOLTS
HIGH WIND
(B16)

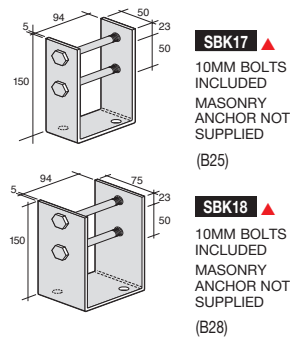

SBK17 ▲
10MM BOLTS
INCLUDED
MASONRY
ANCHOR NOT
SUPPLIED
(B25)

SBK18 ▲
10MM BOLTS
INCLUDED
MASONRY
ANCHOR NOT
SUPPLIED
(B28)

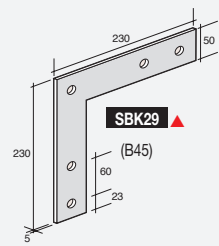

SBK29 ▲
(B45)

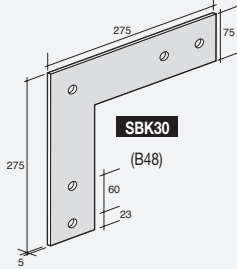

SBK30
(B48)

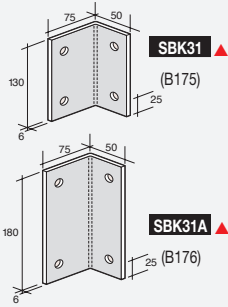

SBK31 ▲
(B175)

SBK31A ▲
(B176)

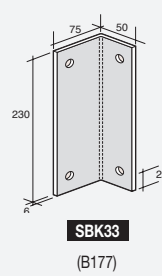

SBK33
(B177)

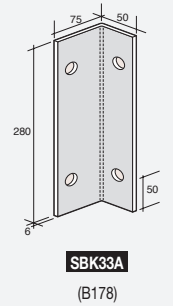

SBK33A
(B178)

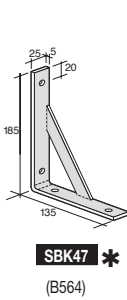

SBK47 *
(B564)

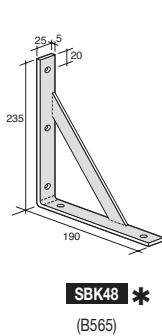

SBK48 *
(B565)

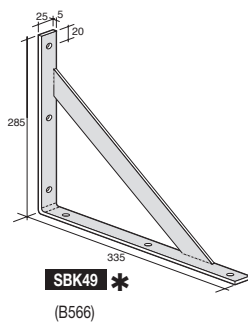

SBK49 *
(B566)

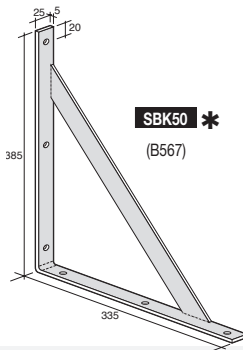

SBK50 *
(B567)

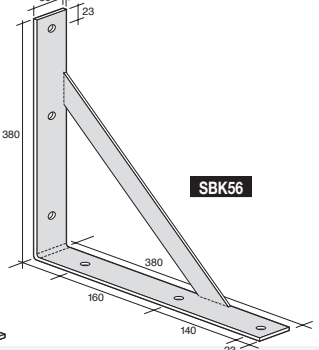

SBK56

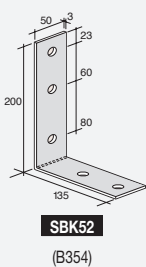

SBK52
(B354)

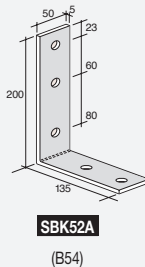

SBK52A
(B54)

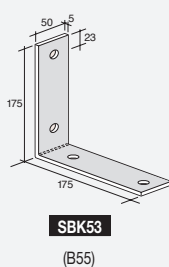

SBK53
(B55)

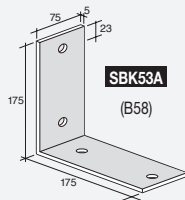

SBK53A
(B58)

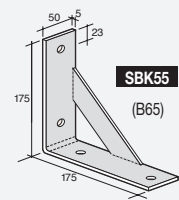

SBK55
(B65)

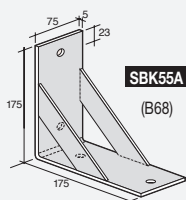

SBK55A
(B68)

ALL BOLT HOLES TO ACCOMMODATE M12 BOLTS UNLESS NOTED.
* BRACKETS WITH HOLES FOR 6MM COUNTERSUNK SCREWS. ELECTROGALVANISED FINISH
▲ ALSO AVAILABLE IN STAINLESS STEEL

GALVANISED AND STAINLESS STEEL PLATES AND BRACKETS FOR CONCRETE, TIMBER AND STEEL CONNECTIONS