

Structural Brackets

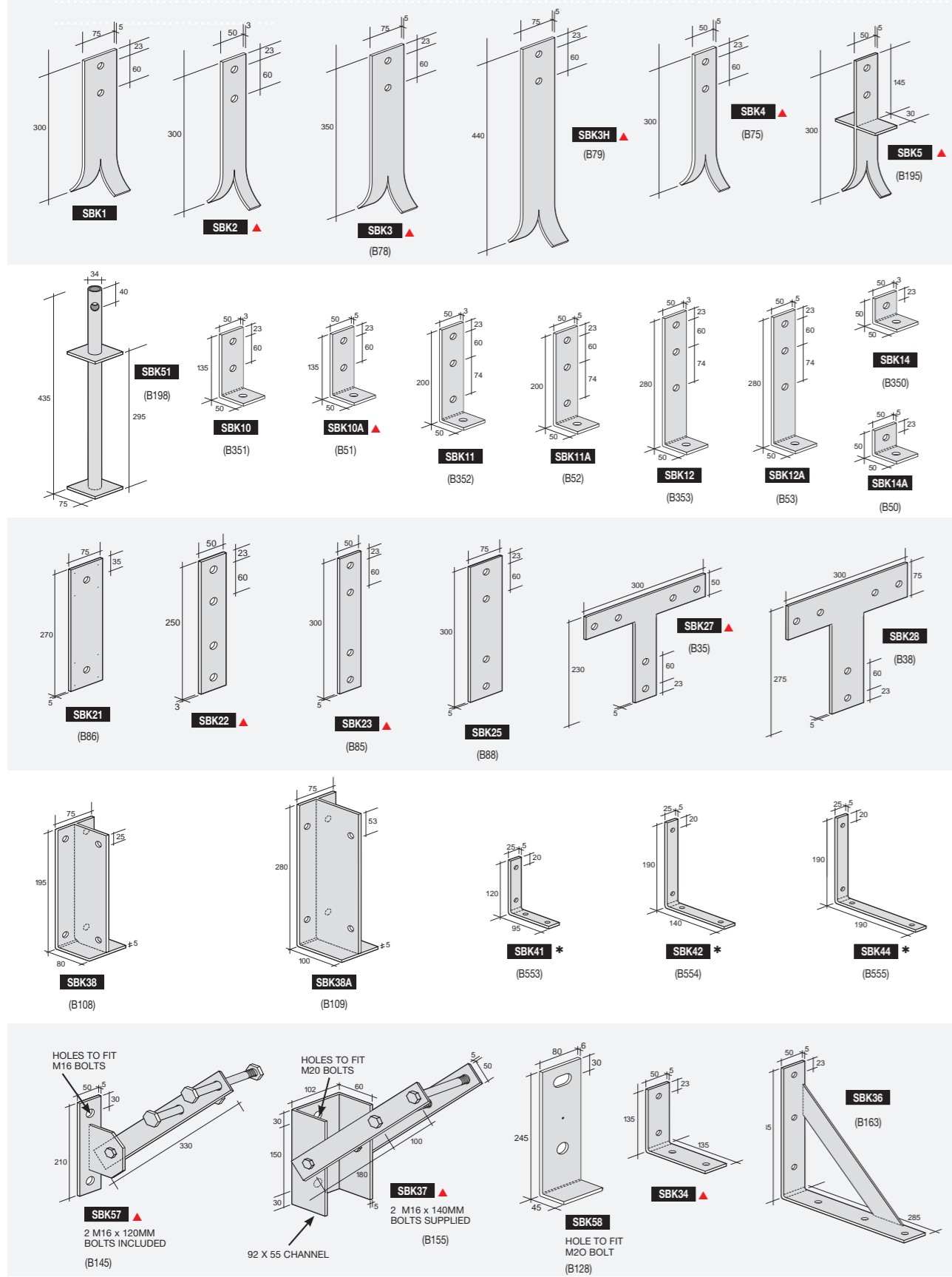

ALL BOLT HOLES TO ACCOMMODATE M12 BOLTS UNLESS NOTED.
 * BRACKETS WITH HOLES FOR 6MM COUNTERSUNK SCREWS. ELECTROGALVANISED FINISH ALSO AVAILABLE IN STAINLESS STEEL
 GALVANISED AND STAINLESS STEEL PLATES AND BRACKETS FOR CONCRETE, TIMBER AND STEEL CONNECTIONS

Structural Brackets

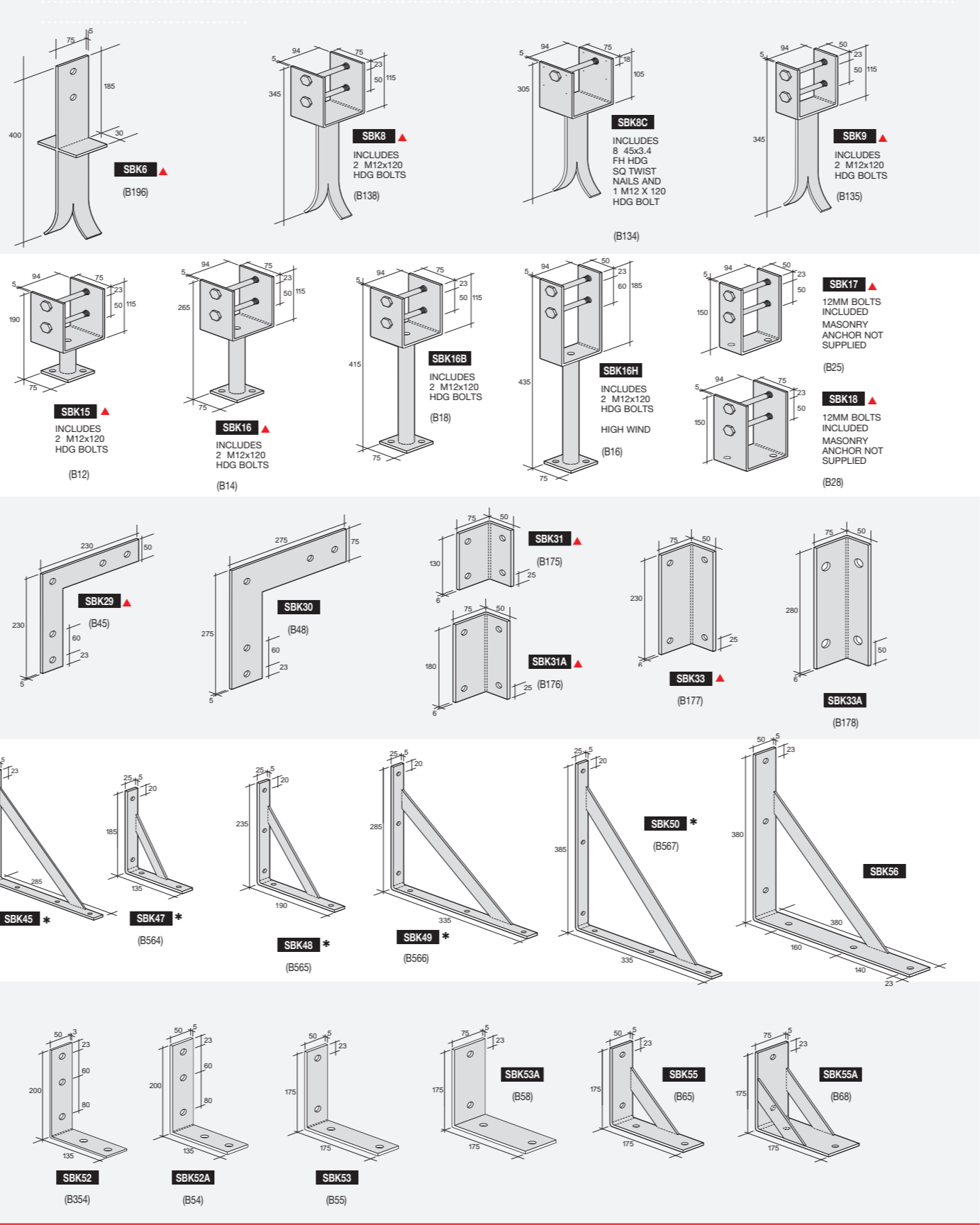

pryda
 A Division of ITW New Zealand Ltd
 Pryda New Zealand
 Head Office: 38 Canaveral Drive, Albany, Auckland Free Phone: 0800 88 22 44
 Website: www.pryda.co.nz
 Offices in Napier, Wellington and Christchurch.
 For contact details in your area visit www.pryda.co.nz or email office@pryda.co.nz

Pryda Mini-Catalogue
 Pryda Timber Connectors

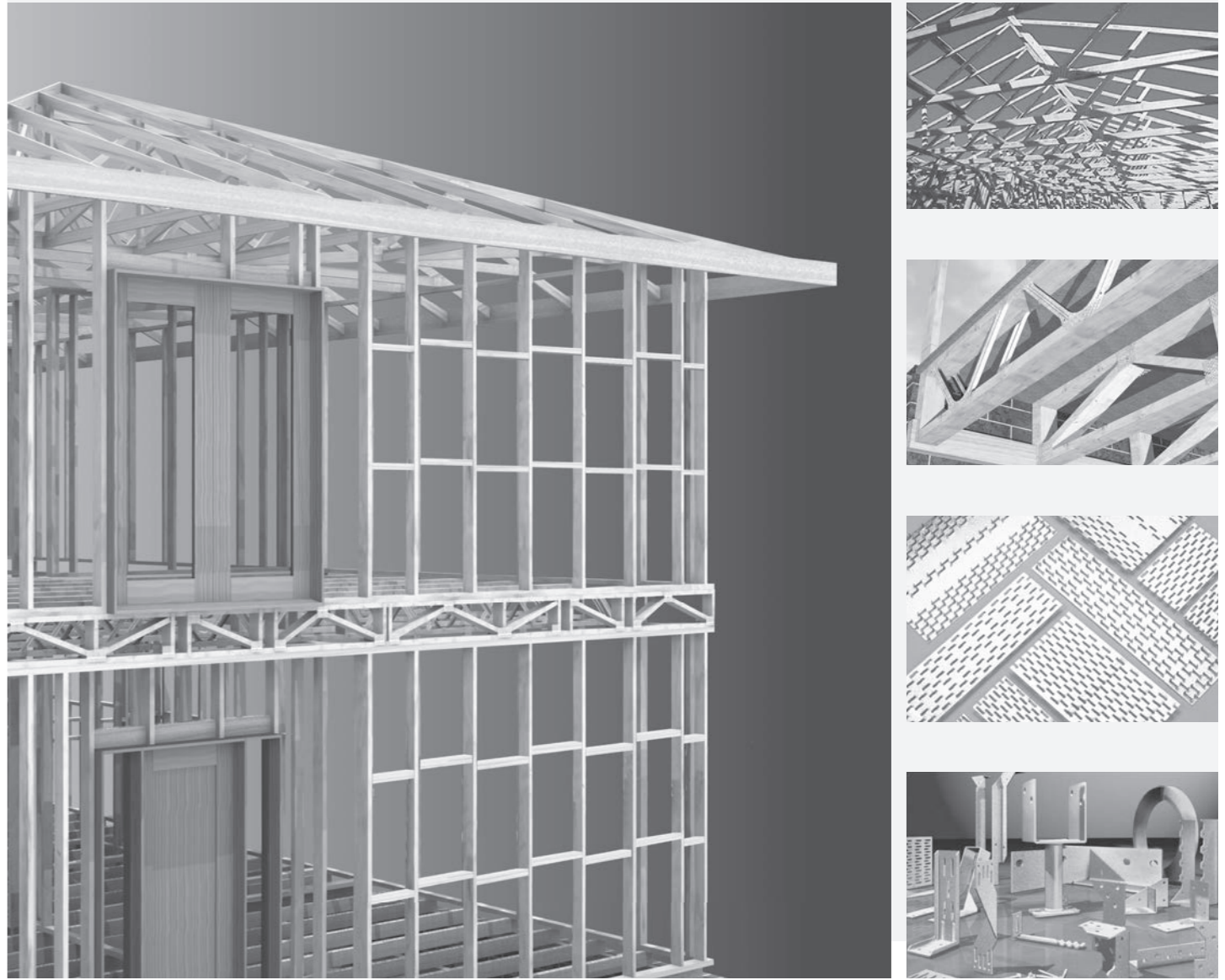

Structural Brackets

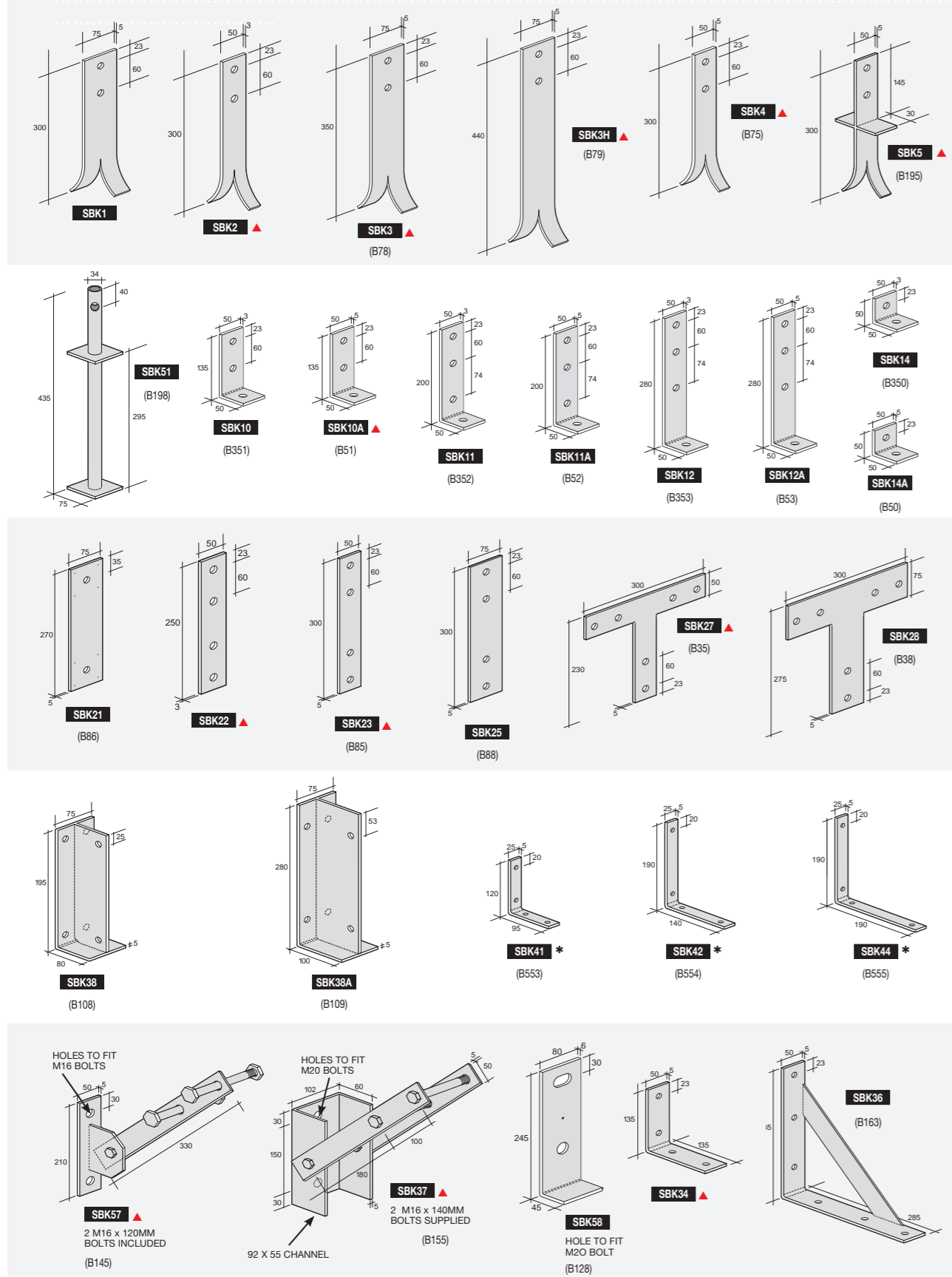

ALL BOLT HOLES TO ACCOMMODATE M12 BOLTS UNLESS NOTED.
* BRACKETS WITH HOLES FOR 6MM COUNTERSUNK SCREWS. ELECTROGALVANISED FINISH ALSO AVAILABLE IN STAINLESS STEEL

GALVANISED AND STAINLESS STEEL PLATES AND BRACKETS FOR CONCRETE, TIMBER AND STEEL CONNECTIONS

Structural Brackets

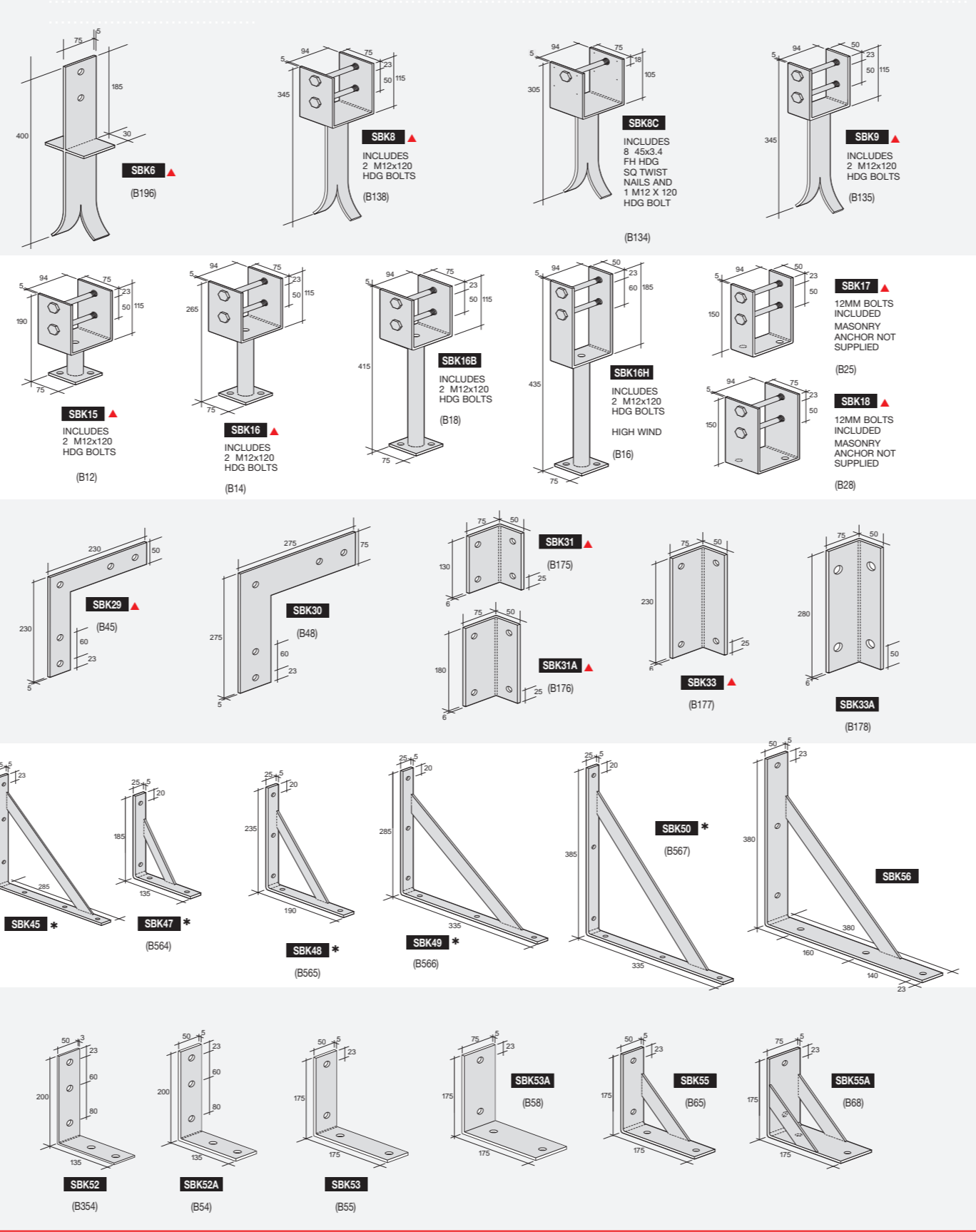

Pryda Mini-Catalogue
Pryda Timber Connectors

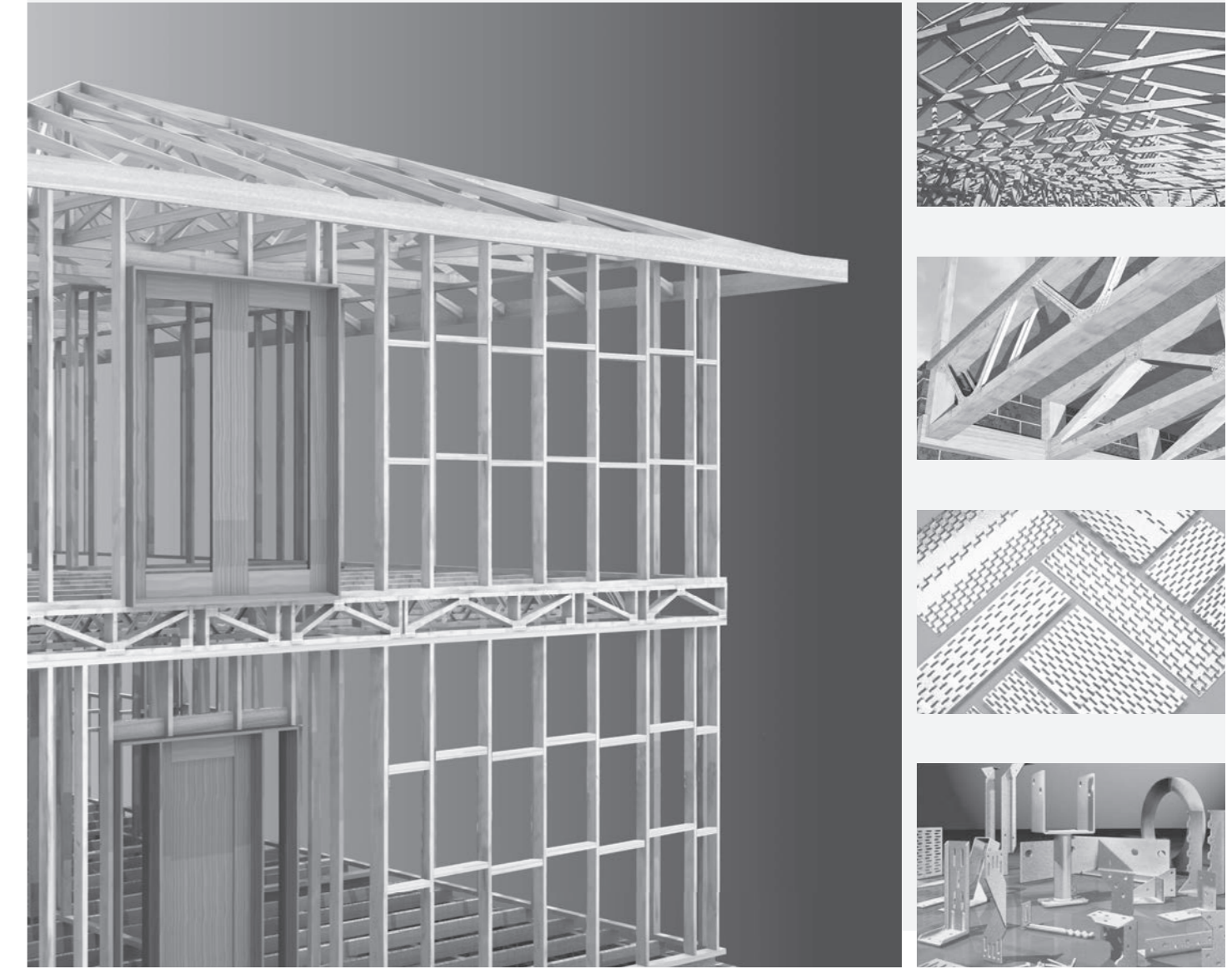

⚡ Nail Plates

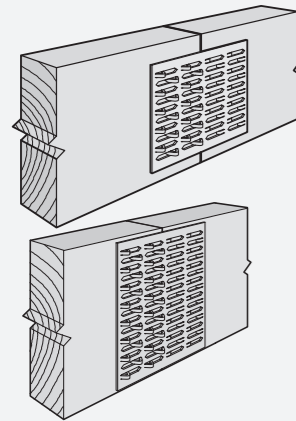

KNUCKLE NAIL PLATES
 MP2R4 33mm wide x 63mm
 MP2R5 38mm wide x 63mm
 MP4R5 38mm wide x 127mm
 MP6R5 38mm wide x 190mm
 MP8R5 38mm wide x 254mm
 MP10R5 38mm wide x 317mm
 MP12R5 38mm wide x 381mm

MP2R10 76mm wide x 63mm
 MP4R10 76mm wide x 127mm
 MP6R10 76mm wide x 190mm
 MP8R10 76mm wide x 254mm
 MP10R10 76mm wide x 317mm
 MP12R10 76mm wide x 381mm

MP2R16 134mm wide x 63mm
 MP4R16 134mm wide x 127mm
 MP6R16 134mm wide x 190mm
 MP8R16 134mm wide x 254mm
 MP10R16 134mm wide x 317mm
 MP12R16 134mm wide x 381mm

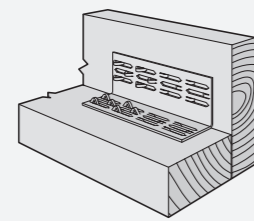

KNUCKLE ANGLE PLATES
 MP2RA 38mm x 38mm x 63mm
 MP3RA 38mm x 38mm x 95mm
 MP4RA 38mm x 38mm x 127mm
 MP6RA 38mm x 38mm x 190mm

KNUCKLE NAIL PLATE COILS
 NCR5 12.7m x 38mm wide
 NCR10 12.7m x 76mm wide
 NCR16 8.45m x 134mm wide

STRAP NAIL
 MPSN2 100mm x 25mm
 MPSN50 100mm x 50mm

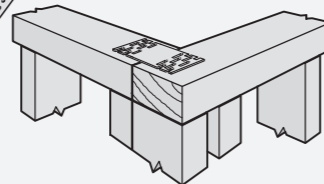
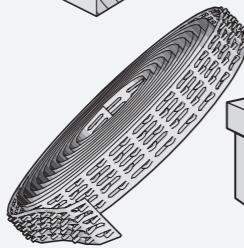

⚡ Bracing

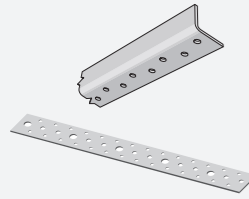

ANGLE BRACE (20 x 20 x 1.0mm)
 AB30 3.0m lengths
 AB33 3.3m lengths
 AB36 3.6m lengths
 AB42 4.2m lengths
 AB48 4.8m lengths

PLUMBER'S STRAP (25 x 0.5mm x 30m)
 PS30 30m coil

STRAP BRACE
 (25 x 0.8mm high tensile)
 SB10 10m coil
 SB30 30m coil
 SB30T 30m coil with tensioners

MAXI STRAP
 (50 x 0.8mm high tensile)
 SBI 30m coil

PRYDA TENSIONERS (incl.T bolts, wingnuts & washers)
 For 25mm Strap brace
 For 50mm Industrial Strap
 SBT
 SBI/T

⚡ Nail-on Plates

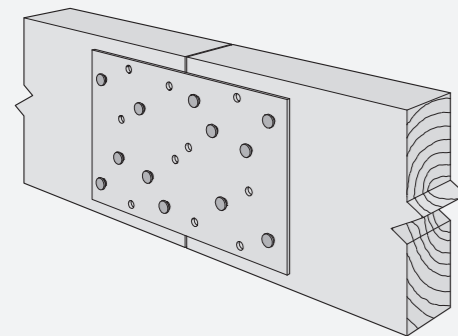

NAIL-ON PLATES
 NPA75/190 75 x 190mm
 NPA75/250 75 x 250mm
 NPA75/315 75 x 315mm
 NPA75/380 75 x 380mm
 NPA100/190 100 x 190mm
 NPA100/250 100 x 250mm
 NPA100/315 100 x 315mm
 NPA150/250 150 x 250mm
 NPA150/315 150 x 315mm

* Also available in 2mm G300 Z275 galvanised steel

STAINLESS STEEL NAIL-ON PLATES
 NPA100/190SS 100 x 190mm

*Also available in 1260mm lengths

⚡ General Fixings

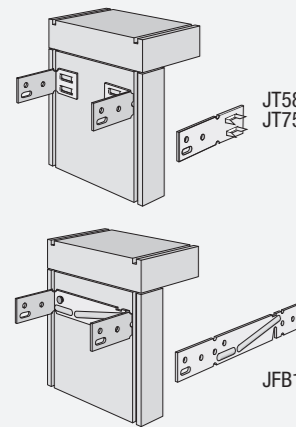

JAMB-TIE
 JT58 18mm wide x 58mm
 JT75 18mm wide x 75mm
 Fits green gauged 100mm or 75mm framing

JAMB FIXA
 To fit GG 100mm or 75mm framing
 JFB100

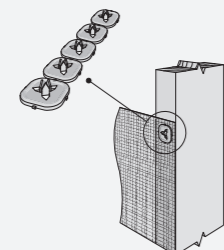

PRYDA FIX (30mm x 30mm)
 SFI 150 strips of 5 - Zinc

FOIL FIX (20mm x 20mm)
 SFF 50 strips of 10 - Zinc

PRYDA GALVANISED PRODUCT NAILS 30 x 3.15mm
 500gm bag 220 nails
 5kg box 2,200 nails
 GBC030315
 GBH030315

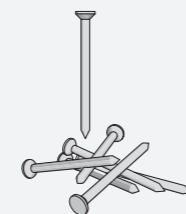

⚡ Brackets, Hangers

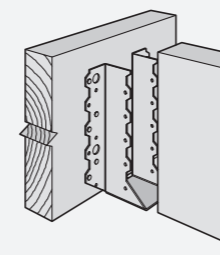

FRAMING BRACKETS / JOIST HANGERS
 MPFB4590 46 x 77mm
 MPFB45120 46 x 111mm
 MPFB45180 46 x 177mm

MPFB5274 52 x 74mm
 MPFB52124 52 x 124mm
 MPFB52174 52 x 174mm
 MPFB3890 39 x 81mm

FB65/170 65 x 170mm
 FB69/165 69 x 165mm
 FB94/152 94 x 152mm

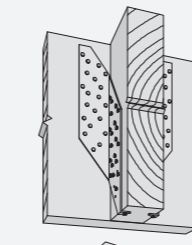

SPLIT JOIST HANGER
 JHHS Over all depth 215mm width adjusts to suit timber

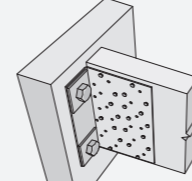

TIM-CON BRACKET
 TCF130 130 x 2.0mm 2 bolts
 TCF190 190 x 2.0mm 2 bolts (washers included)

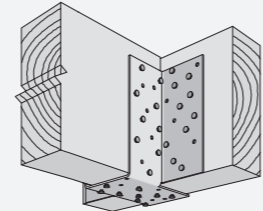

HEAVY DUTY JOIST HANGER
 For 75mm timber width
 JHH75
 JHH100

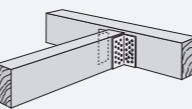

NAILON ANGLE
 NPA 50 x 50 x 1.0mm
 190mm length

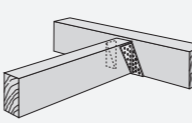

NAILON DIAGONAL CLEAT
 Diagonally folded cleat
 Ex190 x 100 x 1.0mm plate
 Supplied as pair LH & RH
 NPD

⚡ Connectors & Tie-Downs

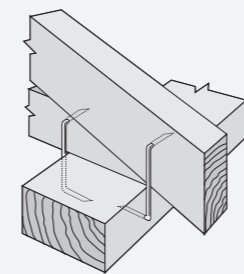

Z NAILS
 ZR or MPZR Z Nails-Right Hand
 ZL or MPZL Z Nails-Left Hand
 ZU or MPZU U Nails

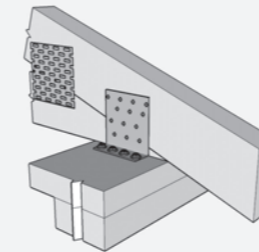

CONCEALED PURLIN CLEATS
 NPPC4 Width 40mm x 2.0mm
 NPPC6 Width 60mm x 2.0mm
 NPPC8 Width 80mm x 2.0mm

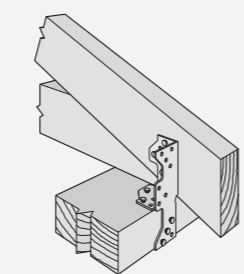

MULTIGRIPS
 MG 100 x 36 x 36mm
 MGL 132 x 36 x 36mm

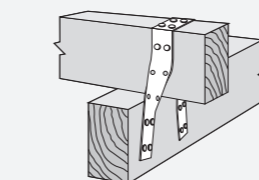

WIND STRAP
 WS4E 400mm x 25mm-flat (16 nails required)
 WS6E 600mm x 25mm-flat (20 nails required)

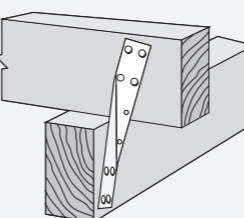

PURLIN HANGER
 CPH126-LH 126mm x 25mm wide
 CPH126-RH 126mm x 25mm wide
 CPH190-LH 190mm x 25mm wide
 CPH190-RH 190mm x 25mm wide

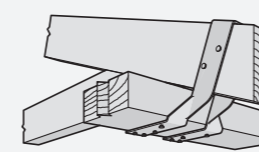

CYCLONE STRAP
 MPQHS4 400mm x 25mm-pretent
 MPQHS6 600mm x 25mm-pretent
 QHS9 900mm x 25mm-pretent



BATTEN STRAP
 BS70

⚡ Subfloor & Panel Fixings

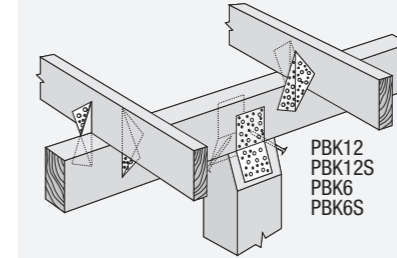

PILE BEARER KIT
 Nail on Plates and Nails for 12kN & 6kN subfloor connections

12kN PILE BEARER KIT-Std (Zone 2&3)
 12kN PILE BEARER KIT-Severe Corrosion (Salt Spray)
 6kN PILE BEARER KIT-Std (Zone 2&3)
 6kN PILE BEARER KIT-Severe Corrosion (Salt Spray)

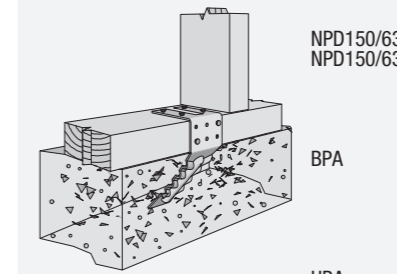

NAILON SIDE PLATES
 150 x 63mm DIAGONAL CLEATS
 150 x 63mm Diag. (Stainless Steel)
 NPD150/63
 NPD150/63/S

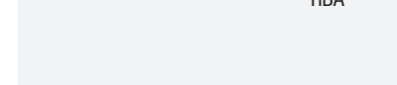

BOTTOM PLATE ANCHOR
 Pressed Steel Bracket for Fixing Timber Wall Plates to Concrete Floors
 235 x 50 x 1.2mm
 BPA



HEADER BLOCK ANCHOR
 Pressed Steel Bracket for Fixing Timber Wall Plates to Concrete Floors
 235 x 50 x 1.2mm
 HBA

SHEET BRACE STRAPS
 6kN or 12kN Capacity Strap Fixing for Sheet-Braced Wall Panels
 SBS300 300 x 25 x 1.0mm
 SBS400 400 x 25 x 1.0mm
 SBS600 600 x 25 x 1.0mm

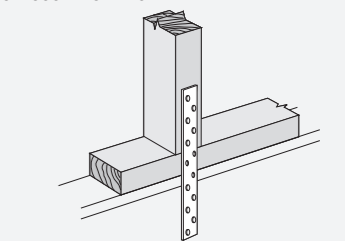

SHEET BRACE ANCHOR
 6kN or 12kN Capacity Bracket Fixing for Sheet-Braced Wall Panels
 75 x 25 x 80mm wide Angle (incl.Nails and Screws)
 SBA

⚡ Stainless Steel Fixings

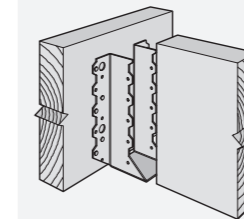

FRAMING BRACKETS
 (10 per carton)
 MPFB4590S 47 x 76mm
 MPFB45120S 47 x 126mm
 MPFB45180S 47 x 176mm
 FB94152S 94 x 152mm

STRAP BRACE
 25mm x 1.0mm Bracing Strap 15m Coil
 Stainless Steel Tensioner (ea)
 SB15/S
 SBT/SS316

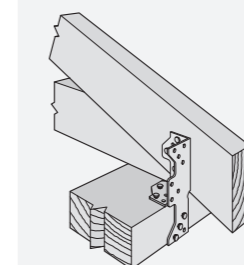

NAIL-ON PLATE
 See Nail-on section inside

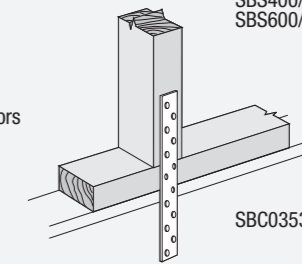

SHEET BRACE STRAPS
 (10 per carton)
 300 x 25 x 1.00mm
 400 x 25 x 1.00mm
 600 x 25 x 1.00mm
 SBS300/S
 SBS400/S
 SBS600/S

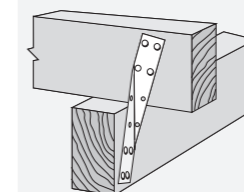

MULTIGRIPS
 (20 per carton)
 Universal Framing Anchors
 MG/S

PRODUCT NAILS
 35 x 3.15 Flat Head S/S
 Bracket Nails
 500gm-170 nails approx

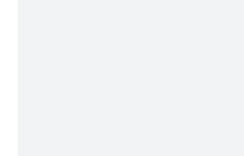

CEILING AND PURLIN HANGER
 (LH or RH) 126mm long
 (LH or RH) 190mm long
 CPH126/S
 CPH190/S

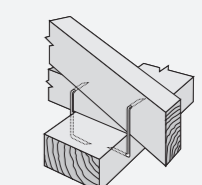

Z NAILS
 Z Nails-Right Hand
 Z Nails-Left Hand
 U Nails
 100 nails per carton
 MPZR/S
 MPZL/S
 MPZU/S